

IT	NAME	MATERIAL	REMARK
1	CORD	△ O-C 3x1.0mm <sup>2</sup>	△
2	BODY	PVC	△
3	BASE	PBT △	C-511

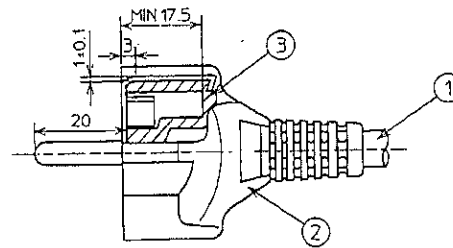

APPROVED	SEMKO	NEMKO	DEMKO	FIMKO
	DVE	VDE	KEMA	CEBEC

△ X				
△ X				
△ X				
△ X 5	再トレース変更, 削除			
LET	REVISION	DATE	SIGN	

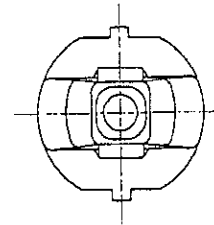
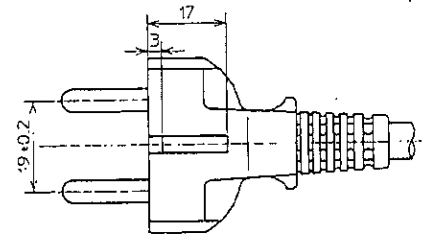
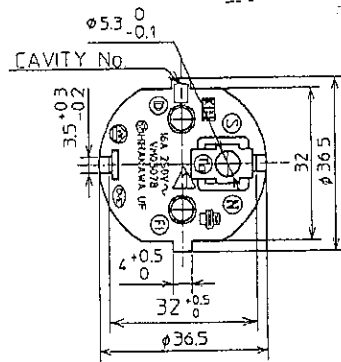
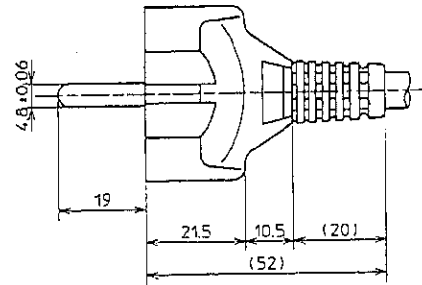
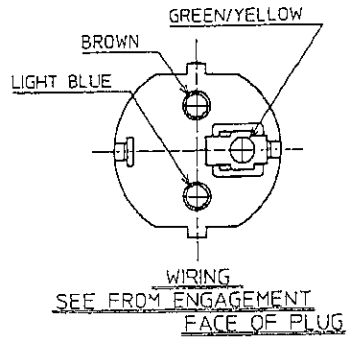

TOLERANCE		ANGLE	SCALE	UNIT
DIMENSION	TOL.	DR. T. Aizawa	1:1	mm
L ≤ 63	± 0.5	DATE Feb. '01		
		CH. L. Igarashi	DATE Feb. 01. 01	
		APP. T. Katsa	DATE Feb. 01. 01	

NAME	IEC 3P-PLUG
PART NO.	VM0307B-A0
DRAWING NO.	MC0158CA

IT	NAME	MATERIAL	REMARK
1	INNER BASE	α66NYLON	C-485A
2	CONTACT SLEEVE	C5191R-1/2H	B-202A
3	BODY	PVC	
4	CORD	O-C 3X1.0mm <sup>2</sup>	

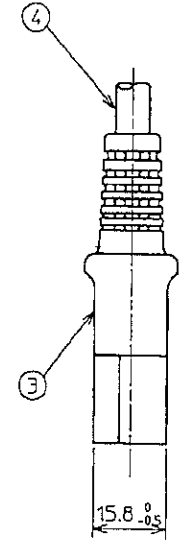
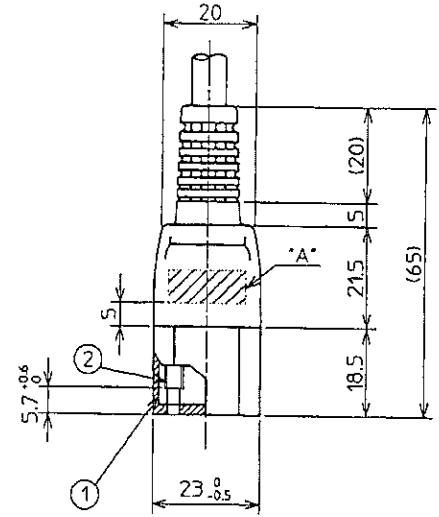
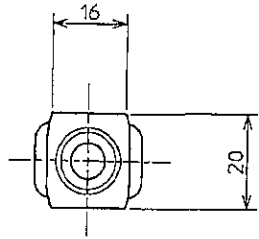

MARKING OF AREA "A"  
 ~ 10A 250V  
 (FI) (D) (N) (S)

MARKING OF THE REVERSE SIDE AREA "A"  
 KEMA  
 CEBC  
 VDE  
 VDE  
 S

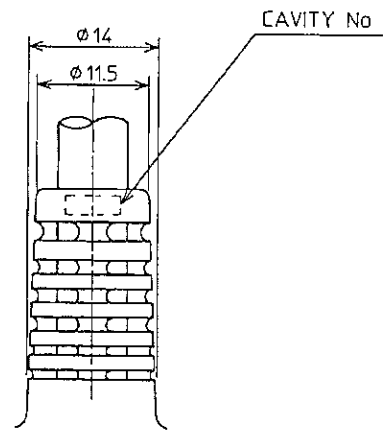

DETAIL OF STRAIN RELIEF  
 2/1

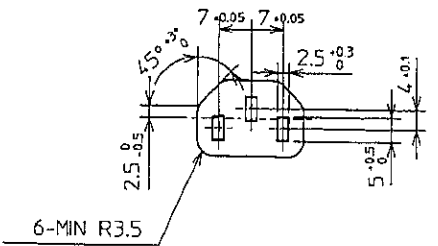
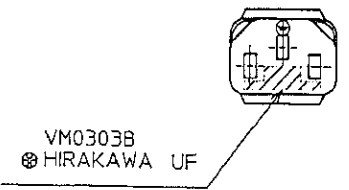

APPROVED	SEMKO	NEMKO	DEMKO	FIMKO	SEV
	VDE	VDE	KEMA	CEBEC	

△X				 HIRAKAWA HEWTECH CORP.	TOLERANCE	ANGLE	SCALE	UNIT	NAME	
△X					DIMENSION		1 : 1	mm	EN 10A 250V - 3P-CONNECTOR	
△X	4	実更・削除	MAR.05'01		T. Katsu		DR. T. AIZAWA	DATE	JUL.24'99	PART NO.
△X		再トレース					CH. I. GARASHI	DATE	SEP.13'99	VM0303B-A0
LET		REVISION			L ≤ 65	APP. T. KATSU	DATE	SEP.13'99	DRAWING NO.	
					±0.5				MC0010CC	